

PIEZOSURGERY® 3 - accessori

LOT 03230006
DEFLUSSORE (50 PZ.)

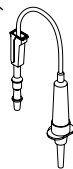

01380002
ASTA PER FISIOLOGICA

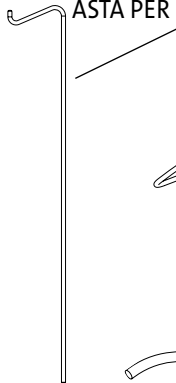

02900040-001
SUPPORTO MANIPOLO

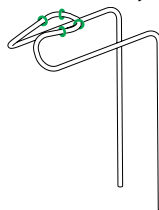

00050030
CAVO ALIMENTAZIONE IT
00050002
CAVO ALIMENTAZIONE
SCHUKO
00050032
CAVO ALIMENTAZIONE
SVIZZERA

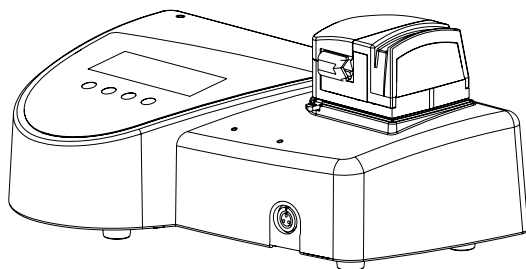
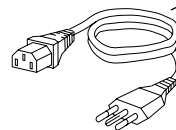

02900039-001
KIT 8 TUBI POMPA (MANIPOLO CON CONNETTORE CORDONE IN METALLO)

02900104-001
KIT 8X PUMP TUBE (MANIPOLO CON CONNETTORE CORDONE IN PLASTICA)

SN 03120023-001
MANIPOLO COMPLETO
DI CORDONE

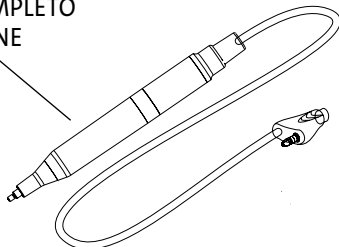

LOT 02900109-001
CHIAVE DINAMOMETRICA K8



02900111
INSERT BOX IN RADEL
(CONTIENE 15 INSERTI)

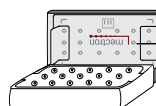

02900037-001
PORTA INSERTI
(CONTIENE 5 INSERTI)



04440007-001
VALIGIA

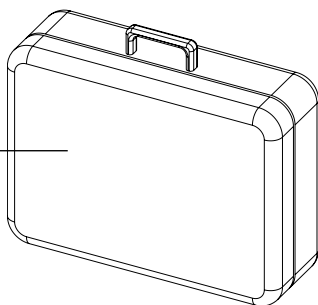

04610004-001
SURGICAL TRAY

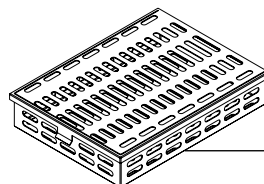

LOT 02900078-001
PEDALE DI COMANDO

