

# PIEZOSURGERY® 3 - accessori

**LOT** 03230006  
DEFLUSSORE (50 PZ.)

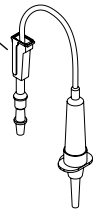

01380002  
ASTA PER FISIOLOGICA

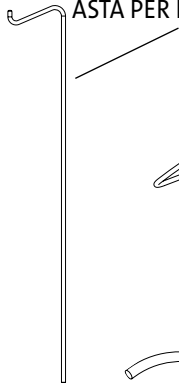

02900040-001  
SUPPORTO MANIPOLO

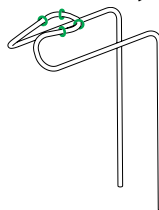

00050030  
CAVO ALIMENTAZIONE IT  
00050002  
CAVO ALIMENTAZIONE  
SCHUKO  
00050032  
CAVO ALIMENTAZIONE  
SVIZZERA

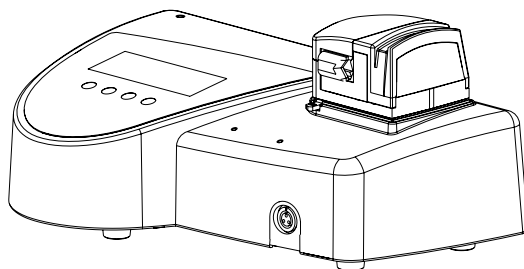
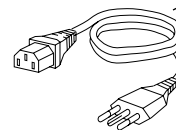

02900039-001  
KIT 8 TUBI POMPA (MANIPOLO CON CONNETTORE CORDONE IN METALLO)  
02900104-001  
KIT 8X PUMP TUBE (MANIPOLO CON CONNETTORE CORDONE IN PLASTICA)

**SN** 03120023-001  
MANIPOLO COMPLETO  
DI CORDONE

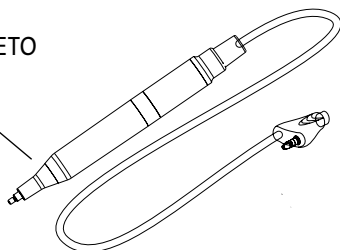

**LOT** 02900109-001  
CHIAVE DINAMOMETRICA K8

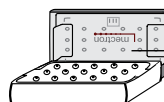

02900111  
INSERT BOX IN RADEL  
(CONTIENE 15 INSERTI)



02900037-001  
PORTA INSERTI  
(CONTIENE 5 INSERTI)

04440007-001  
VALIGIA

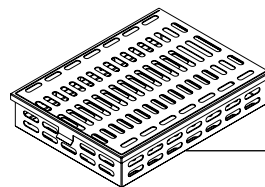
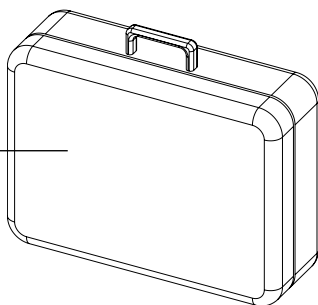

04610004-001  
SURGICAL TRAY

**LOT** 02900020-001  
PEDALE DI COMANDO

